

LED Solar Lighting



LED Solar Flood Light - Economic



IP67

- ☒ Light control
- ☒ Timing
- ☒ Remote Control
- ☒ Power Remaining Display

Die-cast Aluminum

01



No Flicker



CRI:70/80



3000K-6500K



IP67



12 H
2-3 rainy days



32650



6-8 H



180°



50W



100W



200W



300W

Model No. 产品规格	Power 功率	Actual Power 实际功率	Lamp Dimension W*H*L (mm)	Total Lumen 光通量	Solar Panel Spec. 太阳能板参数	Solar Panel Size 太阳能板尺寸 (mm)	PCS/CTN 装箱数量	CTN MEAS. 装箱尺寸 (cm)
XGYSFL-CL801-E50	50W	5W	240*180*83	600LM	6V/12W	350*290*17	10	Lamp: 44.5*39*26 Solar: 38*31*32
					polysilicon		10	
XGYSFL-CL801-E100	100W	10W	260*200*83	1200LM	6V/18W	420*350*17	5	Lamp: 52*33.5*31.5 Solar: 45*31*37
					polysilicon		10	
XGYSFL-CL801-E200	200W	20W	300*240*83	2200LM	6V/20W	450*350*17	5	Lamp: 53*32*39 Solar: 48.5*30*37.5
					polysilicon		10	
XGYSFL-CL801-E300	300W	30W	360*298*83	3300LM	6V/25W	530*350*17	5	Lamp: 53*32*39 Solar: 56.5*32*38
					polysilicon		10	

LED Solar Lighting



LED Solar Flood Light - Standard



No Flicker



CRI:70/80



3000K-6500K



IP65



10-12 H



32650



4-6 H



180°

02

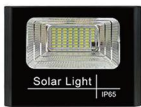

50W

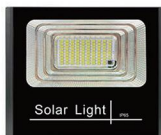

100W

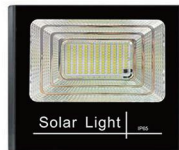

200W

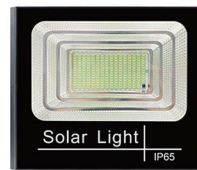

300W

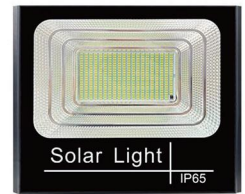

400W

Model No. 产品规格	Rated Power 额定功率	Actual Power 实际功率	Lamp Dimension W*H*L (mm)	Lumen Efficacy 光效	Solar Panel Spec. 太阳能板参数	Solar Panel Size 太阳能板尺寸 (mm)	PCS/CTN 装箱数量	CTN MEAS. 装箱尺寸 (cm)
XGYSFL-SL12-E25	25W	≥8W	193*146*50	150 LM/W	8W	235*350*17	1	195*53*163
XGYSFL-SL12-E40	40W	≥12W	227*180*50	150 LM/W	12W	290*350*17	1	235*57*200
XGYSFL-SL12-E60	60W	≥15W	255*208*65	150 LM/W	18W	400*350*17	1	265*74*220
XGYSFL-SL12-E100	100W	≥25W	300*250*75	150 LM/W	25W	530*350*17	1	318*83*262
XGYSFL-SL12-E200	200W	≥28W	335*270*80	150 LM/W	30W	630*350*17	1	358*86*290
XGYSFL-SL12-E300	300W	≥30W	397*310*85	150 LM/W	35W	680*350*17	1	430*96*335

LED Solar Lighting



LED Solar Flood Light - Premium

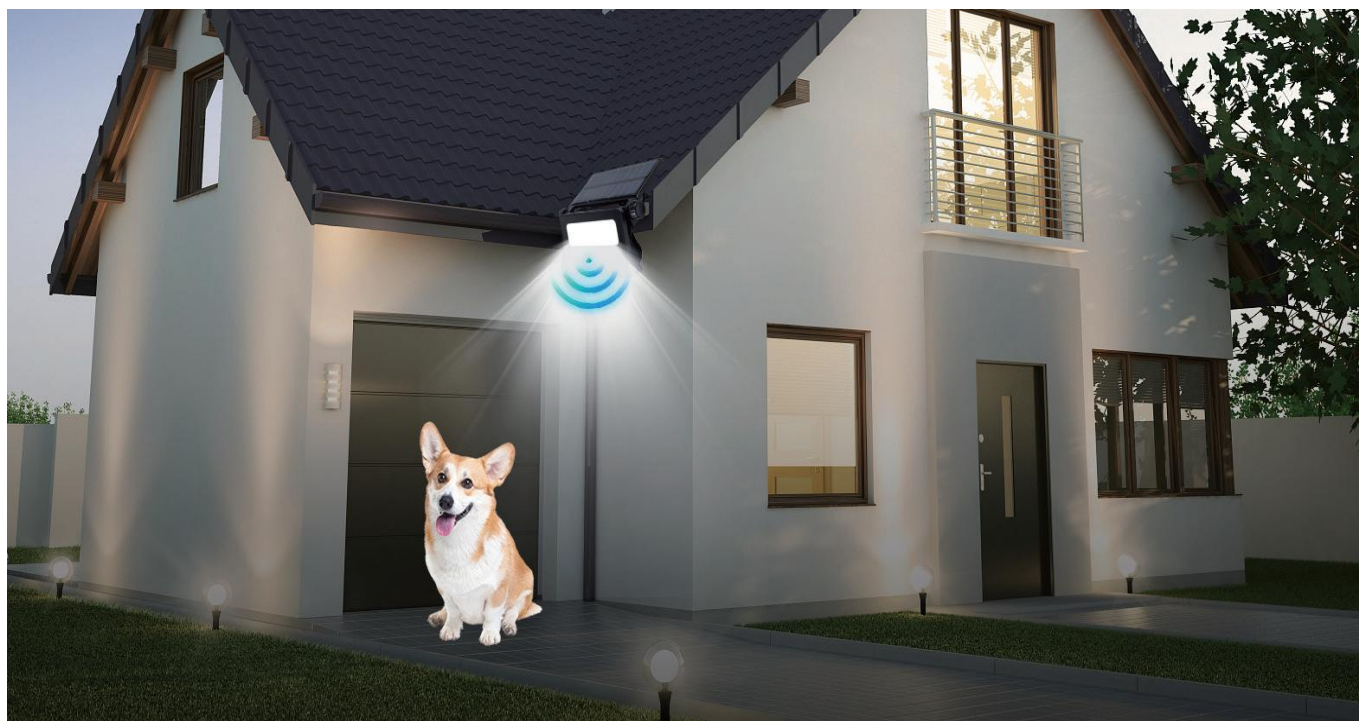

No Flicker



CRI:70/80



3000K-6500K



IP54



180°

03



Tempered Glass Cover

Die Cast Aluminum



Tempered Glass Cover

ABS Body



Rotate

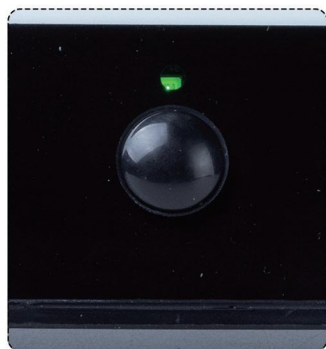

Microwave/PIR Sensor



Glue/PET/ETFE

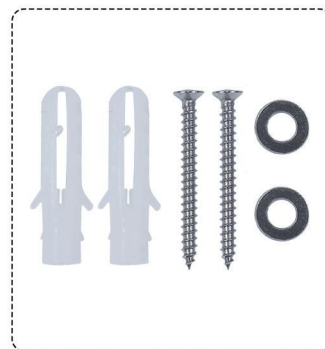

Attachment



IP54



XGY-BD-S3W-850

Dimension W*H*L (mm)	Solar Panel Spec. 太阳能板参数	Sensor Type 感应方式
257*231*32	9W / 4W PET Polysilicon SP	MS Sensor / Metal Switch Batter Replacable
Total Lumen 光通量	Body Material 材质	Battery Capacity 电池容量
2500LM	ALU+GLASS	2*18650 3.7V/2000mAh
Using / Charing Time 使用 / 充电时间	PCS/CTN 装箱数量	CTN MEAS. 装箱尺寸 (CM)
Use 8-10hrs Charge 13-14hrs	16	45.5*38*17



IP54



XGY-BD-S3D-1000

Dimension W*H*L (mm)	Solar Panel Spec. 太阳能板参数	Sensor Type 感应方式
197*145*32	5.5V / 2W PET Polysilicon SP	MS Sensor / Metal Switch Batter Replacable
Total Lumen 光通量	Body Material 材质	Battery Capacity 电池容量
1000LM	ALU+GLASS	1*18650 3.7V/2000mAh
Using / Charing Time 使用 / 充电时间	PCS/CTN 装箱数量	CTN MEAS. 装箱尺寸 (CM)
Use 8-10hrs Charge 6-7hrs	20	32.5*32*25



IP54



XGY-BD-S3-850

Dimension W*H*L (mm)	Solar Panel Spec. 太阳能板参数	Sensor Type 感应方式
172*145*32	5.5V / 1W PET Polysilicon SP	PIR Sensor
Total Lumen 光通量	Body Material 材质	Battery Capacity 电池容量
850LM	ABS+Glass	1*18650 3.7V/2000mAh
Using / Charing Time 使用 / 充电时间	PCS/CTN 装箱数量	CTN MEAS. 装箱尺寸 (CM)
Use 8-10hrs Charge 11-12hrs	20	33*22*37



IP54



XGY-BD-S3-N200

Dimension W*H*L (mm)	Solar Panel Spec. 太阳能板参数	Sensor Type 感应方式
172*145*32	5V / 1W PET Polysilicon SP	Always On
Total Lumen 光通量	Body Material 材质	Battery Capacity 电池容量
200LM	ABS+Glass	1*18650 3.7V/1200mAh
Using / Charing Time 使用 / 充电时间	PCS/CTN 装箱数量	CTN MEAS. 装箱尺寸 (CM)
Use 5hrs Charge 8-9hrs	20	33*22*37



IP54



XGY-BD-S3P1-800

Dimension W*H*L (mm)	Solar Panel Spec. 太阳能板参数	Sensor Type 感应方式
147.2*179.6*39.8	5.5V / 1.2W PET Polysilicon SP	PIR Sensor / Plastic Switch Batter Replacable
Total Lumen 光通量	Body Material 材质	Battery Capacity 电池容量
800LM	ABS+Glass	1*18650 2000mAh
Using / Charing Time 使用 / 充电时间	PCS/CTN 装箱数量	CTN MEAS. 装箱尺寸 (CM)
Use 8-10hrs Charge 9-10hrs	20	32.5*32*25



IP54



XGY-BD-S3P2-1500

Dimension W*H*L (mm)	Solar Panel Spec. 太阳能板参数	Sensor Type 感应方式
192*165*37	5.5V / 2W PET Polysilicon SP	PIR Sensor / Plastic Switch Batter Replacable
Total Lumen 光通量	Body Material 材质	Battery Capacity 电池容量
1500LM	ABS+Glass	1*18650 2600mAh
Using / Charing Time 使用 / 充电时间	PCS/CTN 装箱数量	CTN MEAS. 装箱尺寸 (CM)
Use 8-10hrs Charge 7-8hrs	20	37*29.5*25



IP54



XGY-BD-S3P1W-800

Dimension W*H*L (mm)	Solar Panel Spec. 太阳能板参数	Sensor Type 感应方式
147.2*179.6*39.8	5V / 1.2W ETFE Polysilicon SP	PIR Sensor / Plastic Switch Batter Replacable
Total Lumen 光通量	Body Material 材质	Battery Capacity 电池容量
850LM	ABS+Glass	1*18650 2000mAh
Using / Charing Time 使用 / 充电时间	PCS/CTN 装箱数量	CTN MEAS. 装箱尺寸 (CM)
Use 8-10hrs Charge 6-7hrs	20	32.5*32*25



IP54



XGY-BD-S3P2W-1500

Dimension W*H*L (mm)	Solar Panel Spec. 太阳能板参数	Sensor Type 感应方式
167.3*189.1*36.5	5.5V / 2W ETFE Polysilicon SP	PIR Sensor / Plastic Switch Batter Replacable
Total Lumen 光通量	Body Material 材质	Battery Capacity 电池容量
1600LM	ABS+Glass	1*18650 2600mAh
Using / Charing Time 使用 / 充电时间	PCS/CTN 装箱数量	CTN MEAS. 装箱尺寸 (CM)
Use 8-10hrs Charge 8-9hrs	20	37*29.5*25

LED Solar Lighting



LED Solar Flood Light - Premium



- ☒ IR Sensor On/Off
- ☒ IR Sensor On/Dim Mode
- ☒ No Sensor Dim Mode
- ☒ IR Sensor
- ☒ 3 Light Mod
- ☒ IR Sensor + Remote

ABS+PC



No Flicker



CRI:70/80



3000K-6500K



IP44



6-8 H



(1-4)*18650



8-10 H



180°

05



0073



0068



0028



0029



0063



0025

Model No. 产品规格	Rated Power 额定功率	Lamp Dimension W*H*L (mm)	Total Lumen 光通量	Solar Panel Spec. 太阳能板参数	Battery Capacity 电池容量	PCS/CTN 装箱数量	CTN MEAS. 装箱尺寸 (cm)
XGYSFL-FL0073-E3	3W	130*95*60	200LM	5.5V / 0.8W Polysilicon	2*18650 1200mAh	60	64*36*64
XGYSFL-FL0068-E3	3W	220*160*100	150LM	5.5V / 2.5W Polysilicon	2*18650 1800mAh	40	61*41*60
XGYSFL-FL0028-E3	3W	155*90*105	300LM	5.5V / 1.5W Polysilicon	1*18650 2000mAh	32	38*32.5*44.5
XGYSFL-FL0029-E3	3W	157*116*57	300LM	5.5V / 1.5W Polysilicon	2*18650 1200mAh	30	62*40*39
XGYSFL-FL0063-E3	3W	210*133*114	300LM	5.5V / 1.5W Polysilicon	2*18650 1200mAh	30	62*40*37
XGYSFL-FL0025-E3	3W	250*180*140	800/400/45LM Remote Adjustable	6V / 3W Monocrystalline	4*18650 1200mAh	18	53*43.5*55.5

LED Solar Lighting



LED Solar Wall Lamp (Decorative)



Light Sensor



No Flicker



CRI:70/80



3000K-6500K



IP54



6-10 H



18650



180°

06



228TJ



228FK



53



228BK



228RY

Model No. 产品规格	Rated Power 额定功率	Dimension W*H*T (mm)	Total Lumen 光通量	Solar Panel Spec. 太阳能板参数	Battery Capacity 电池容量	Body Material 材质	PCS/CTN 装箱数量	CTN MEAS. 装箱尺寸 (cm)
XGYSWL-XY228TJ-E1	1W	89*57*23	8LM	2V / 0.3W Polysilicon	1*NiMH AA Cell 1.2V 600mAh	ABS+PC	192	41.5*27.5*36
XGYSWL-XY228FK-E1	1W	110*60*23	8LM	2V / 0.36W Polysilicon	1*NiMH AA Cell 1.2V 600mAh	ABS+PC	150	35.5*31*38.6
XGYSWL-XY0053-E1	1W	100*75*30	8LM	2V / 0.24W Polysilicon	1*NiMH AA Cell 1.2V 600mAh	ABS+PC	100	46*40*26
XGYSWL-XY228BK-E1	1W	100*75*20	8LM	2V / 0.16W Polysilicon	1*Ni-CD Cell 1.2V 300mAh	ABS+PVC	240	38.5*33.5*42.5
XGYSWL-XY228RY-E1	1W	160*59*33	8LM	2V / 0.2W Polysilicon	1*NiMH AAA Cell 1.2V 600mAh	ABS+PVC	144	51.8*38.9*32

LED Solar Lighting



LED Solar Wall Lamp



07



No Flicker



CRI:70/80



3000K-6500K



IP54



6-10 H



2200mAh



8-10 H

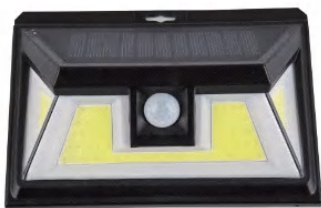

0004



0015



0018



0011

Model No. 产品规格	Rated Power 额定功率	Dimension W*H*T (mm)	Total Lumen 光通量	Solar Panel Spec. 太阳能板参数	Battery Capacity 电池容量	PCS/CTN 装箱数量	CTN MEAS. 装箱尺寸 (cm)
XGYSWL-FL0004-E3	3W	153*105*45	300LM	5.5V / 1.0W Polysilicon PR	1*18650 2200mAh	50	59.5*30*34.5
XGYSWL-FL0015-E3	3W	120*192*40	300LM	5.5V / 1.0W Polysilicon PR	2*18650 1200mAh	60	56*42*40
XGYSWL-FL0018-E3	3W	140*113*60	150LM	5.5V / 0.5W Polysilicon PR	1*18650 1200mAh	90	61*46*47
XGYSWL-FL0011-E2	2W	130*95*60	150LM	5.5V / 1.55W Polysilicon PR	1*18650 1200mAh	100	54*30*52



0620



0630



0120



0130



0224



0354

Model No. 产品规格	Rated Power 额定功率	Dimension W*H*T (mm)	Total Lumen 光通量	Solar Panel Spec. 太阳能板参数	Battery Capacity 电池容量	PCS/CTN 装箱数量	CTN MEAS. 装箱尺寸 (cm)
XGYSWL-FL0620L-E3	3W	96*124*48	150LM	5.5V / 0.5W Polysilicon PR	1*18650 1200mAh	100	60*27*53
XGYSWL-FL0630L-E3	3W	96*124*48	150LM	5.5V / 0.5W Polysilicon PR	1*18650 1200mAh	100	60*27*53
XGYSWL-FL0120L-E3	3W	172*115*45	200LM	5.5V / 0.8W Polysilicon PR	1*18650 1200mAh	50	62.5*37*27
XGYSWL-FL0130L-E3	3W	103*114*42	200LM	5.5V / 0.55W Polysilicon PR	1*18650 1200mAh	50	60*26.5*25.5
XGYSWL-FL0224L-E3	3W	152*105*45	200LM	5.5V / 1.0W Polysilicon PR	1*18650 1200mAh	50	60*30*34.5
XGYSWL-FL0354L-E3	3W	300*105*50	200LM	5.5V / 1.3W Polysilicon PR	2*18650 2000mAh	25	60*30*32.5

LED Solar Lighting



LED Solar Landscape Light



No Flicker



CRI:70/80



3000K-6500K



IP54



Use 6-8 H
Charge 8-10 H



360°

09



GL800

GL8039

GL8018

GL8019

GL8022

GL8013

GL8001

Model No. 产品规格	Rated Power 额定功率	Dimension W*H*T (mm)	Solar Panel Spec. 太阳能板参数	Total Lumen 光通量	Battery Capacity 电池容量	Body Material 材质	PCS/CTN 装箱数量	CTN MEAS. 装箱尺寸 (cm)
XGY-SH-BT-GL8039	1W	Φ140*630	5.5V / 1.5W Polysilicon Solar Panel	200LM	1*18650 1500mAh	ABS+PPA	20	74*31*26
XGY-SH-BT-GL8018	1W	86*86*380	2.2V / 0.88W Monocrystalline solar panel	10LM	1*NiMH batteries 300mAh	ABS	100	51.5*42*50
XGY-SH-BT-GL8019	1W	120*120*425	2.2V / 0.35W Polysilicon Solar Panel	10LM	1*NiMH batteries 600mAh	Glass+Stainless Steel	32	52.5*46.5*36.5
XGY-SH-BT-GL800	1W	Φ108*130	2.0V / 0.24W Polysilicon Solar Panel	RGB	1.2V AA batteries 300mAh	PS+PP	120	62*30*36
XGY-SH-BT-GL8001	1W	Φ120*250	2.0V / 0.24W Polysilicon Solar Panel	RGB	1.2V AA batteries 300mAh	PS+Stainless Steel	120	64.5*26*39.5
XGY-SH-BT-GL8013	1W	102*143*328	2.2V / 1.2W Polysilicon Solar Panel	100LM	1*18650 2000mAh	ABS+PC	40	50*49*40
XGY-SH-BT-GL8022	1W	130*130*465	2.0V / 0.24W Polysilicon Solar Panel	50LM	1.2V AA batteries 300mAh	Plastic+Glass	32	54*54*40

LED Solar Lighting



LED Solar Garden Light



Light Sensor



No Flicker



CRI:70/80



3000K-6500K



IP54



Use 8-11 H
Charge 5-6 H



360°



White

Warm



10

Model No. 产品规格	Rated Power 额定功率	Solar Panel Spec. 太阳能板参数	Total Lumen 光通量	Battery Capacity 电池容量	Body Material 材质	PCS/CTN 装箱数量	CTN MEAS. 装箱尺寸 (cm)
XGYSGL-YD238-E4	4W	5V/3.7W Monocrystalline	360LM	18650Li battery 3.7V/4000mAh	Die-cast Alu +PMMA	8	60*60*39

LED Solar Lighting



LED Solar Garden Light



☒ Light Sensor



No Flicker



CRI:70/80



3000K-6500K



IP54



Use 12-14 H
Charge 5-6 H



360°

11



White

Warm



Model No. 产品规格	Rated Power 额定功率	Solar Panel Spec. 太阳能板参数	Total Lumen 光通量	Battery Capacity 电池容量	Body Material 材质	PCS/CTN 装箱数量	CTN MEAS. 装箱尺寸 (cm)
XGYSGL-YD087-E4	4W	5V/3.7W Monocrystalline	360LM	18650Li battery 3.7V/4000mAh	Alu+PC	4	50*50*31.5

LED Solar Lighting



LED Solar Garden Light

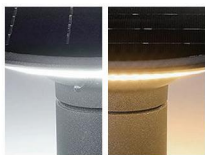

White Warm

12

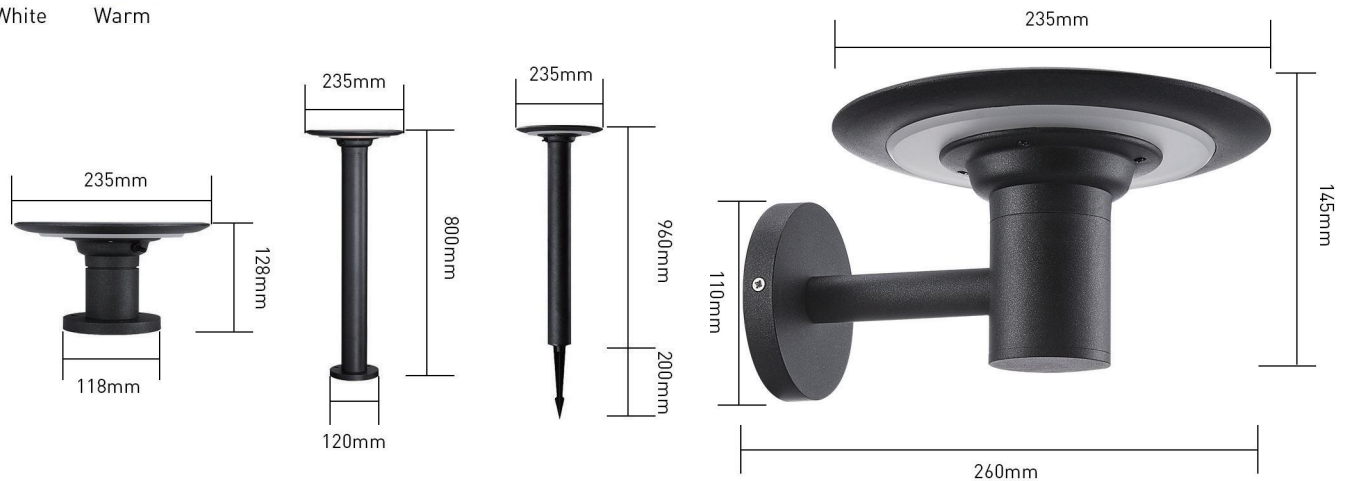

Model No. 产品规格	Rated Power 额定功率	Solar Panel Spec. 太阳能板参数	Total Lumen 光通量	Battery Capacity 电池容量	Body Material 材质	PCS/CTN 装箱数量	CTN MEAS. 装箱尺寸 (cm)
XGYSGL-YD231-E4	4W	5V/3.7W Monocrystalline	360LM	18650Li battery 3.7V/4400mAh	Alu+PMMA	1	28*28*17.5

LED Solar Lighting



LED Solar Garden Light



No Flicker



CRI:70/80



3000K-6500K



IP54



Use 10-12 H
Charge 5-6 H



360°

13

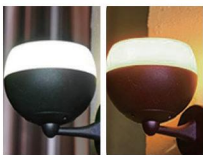

White

Warm

Mobile APP intelligent control:

- ☒ Support 4 default scenes and DIY scene selection,
- ☒ Power management, low power reminder function
- ☒ Adjust the light
- ☒ Turn the lights on/off regularly
- ☒ Support lighting and music Sync.

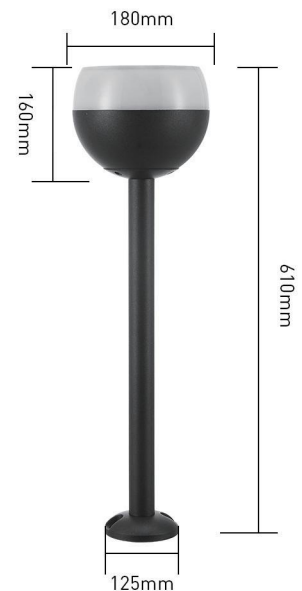

Model No. 产品规格	Rated Power 额定功率	Solar Panel Spec. 太阳能板参数	Total Lumen 光通量	Battery Capacity 电池容量	Body Material 材质	PCS/CTN 装箱数量	CTN MEAS. 装箱尺寸 (cm)
XGYSGL-YD404-E3	2-3W	Single crystal glass lamine150*2.0mm 5V/2W	200LM	3.7 4000mAh	Alu+PC	8	46*46*57

LED Solar Lighting



LED Solar Garden Light



White

Warm



14

Mobile APP intelligent control:

- ☒ Support 4 default scenes and DIY scene selection,
- ☒ Power management, low power reminder function
- ☒ Adjust the light
- ☒ Turn the lights on/off regularly
- ☒ Support lighting and music Sync.

Model No. 产品规格	Rated Power 额定功率	Solar Panel Spec. 太阳能板参数	Total Lumen 光通量	Battery Capacity 电池容量	Body Material 材质	PCS/CTN 装箱数量	CTN MEAS. 装箱尺寸 (cm)
XGYSGL-YD11829-E3	3w	195*115Glass laminate, polycrystalline5V/3W	210LM	18650Ternary lithium battery3.7V/2500mAh	Alu+PC	4	70*54*39.5

LED Solar Lighting



LED Solar Garden Light



15



White Warm

Remote control mode:

- ☒ ON/OFF key: Turn on or off the light
- ☒ ☀, ● key: 100% brightness, 50% brightness
- ☒ M key: Toggle full light or dimmed light
- ☒ + and - keys: Increase or decrease brightness by 5%
- ☒ AUTO: Smart light automatically reduces the power
- ☒ 3H, 5H, and 8H keys: Turn off the light after the timing is 3H, 5H, and 8H.



Model No. 产品规格	Rated Power 额定功率	Solar Panel Spec. 太阳能板参数	Total Lumen 光通量	Battery Capacity 电池容量	Body Material 材质	PCS/CTN 装箱数量	CTN MEAS. 装箱尺寸 (cm)
XGYSGL-YD535-E20	20W	Monocrystalline silicon glass plate 418*3.2mm 5V/20W	1500LM	32700LFP 3.2V/24000mAh	Alu+PC	1	48*48*57

LED Solar Lighting



LED Solar Garden Light



White Warm

Remote control mode:

- ☒ ON/OFF key: Turn on or off the light
- ☒ ☀, ● key: 100% brightness, 50% brightness
- ☒ M key: Toggle full light or dimmed light
- ☒ + and - keys: Increase or decrease brightness by 5%
- ☒ AUTO: Smart light automatically reduces the power
- ☒ 3H, 5H, and 8H keys: Turn off the light after the timing is 3H, 5H, and 8H.



16

Model No. 产品规格	Rated Power 额定功率	Solar Panel Spec. 太阳能板参数	Total Lumen 光通量	Battery Capacity 电池容量	Body Material 材质	PCS/CTN 装箱数量	CTN MEAS. 装箱尺寸 (cm)
XGYSGL-YD536-E	20W	P418Glass laminate monocrystalline silicon5V/20W	1500LM	26700LFP 32V/20000mAh	Alu+PC	1	48*48*43cm
XGYSGL-YD615-E			1800LM		Alu+PMMA	1	48*48*26cm

LED Solar Lighting



LED Solar Street Light



Control Mode: Light control+Induction light control+Remote control



No Flicker



CRI:70/80



3000K-6500K



IP65



Use 8-12 H Charge 4-6 H



360°

17



E30



E60



E90



E120



E150

Model No. 产品规格	Rated Power 额定功率	Dimension W*H*T (mm)	Solar Panel Spec. 太阳能板参数	Solar Panel Size 太阳能板尺寸 (mm)	Battery Capacity 电池容量	Mounting Height 安装高度	PCS/CTN 装箱数量	CTN MEAS. 装箱尺寸 (cm)
XGYSSL-XWWZ-E30	30W	39*20	6W/6V	301*187	5000mAh	2-5M	10	41*32.5*42
XGYSSL-XWWZ-E60	60W	49*21	8W/6V	398*213	5000mAh	3-5M	10	50.5*31.5*47
XGYSSL-XWWZ-E90	90W	62*24	12W/6V	508*231	10000mAh	4-6M	5	64.5*32*27
XGYSSL-XWWZ-E120	120W	72*24	15W/6V	608*231	15000mAh	5-6M	5	74.5*33*27
XGYSSL-XWWZ-E150	150W	82*24	18W/6V	708*231	15000mAh	6-8M	5	84.5*35*25

LED Solar Lighting



LED Solar Street Light

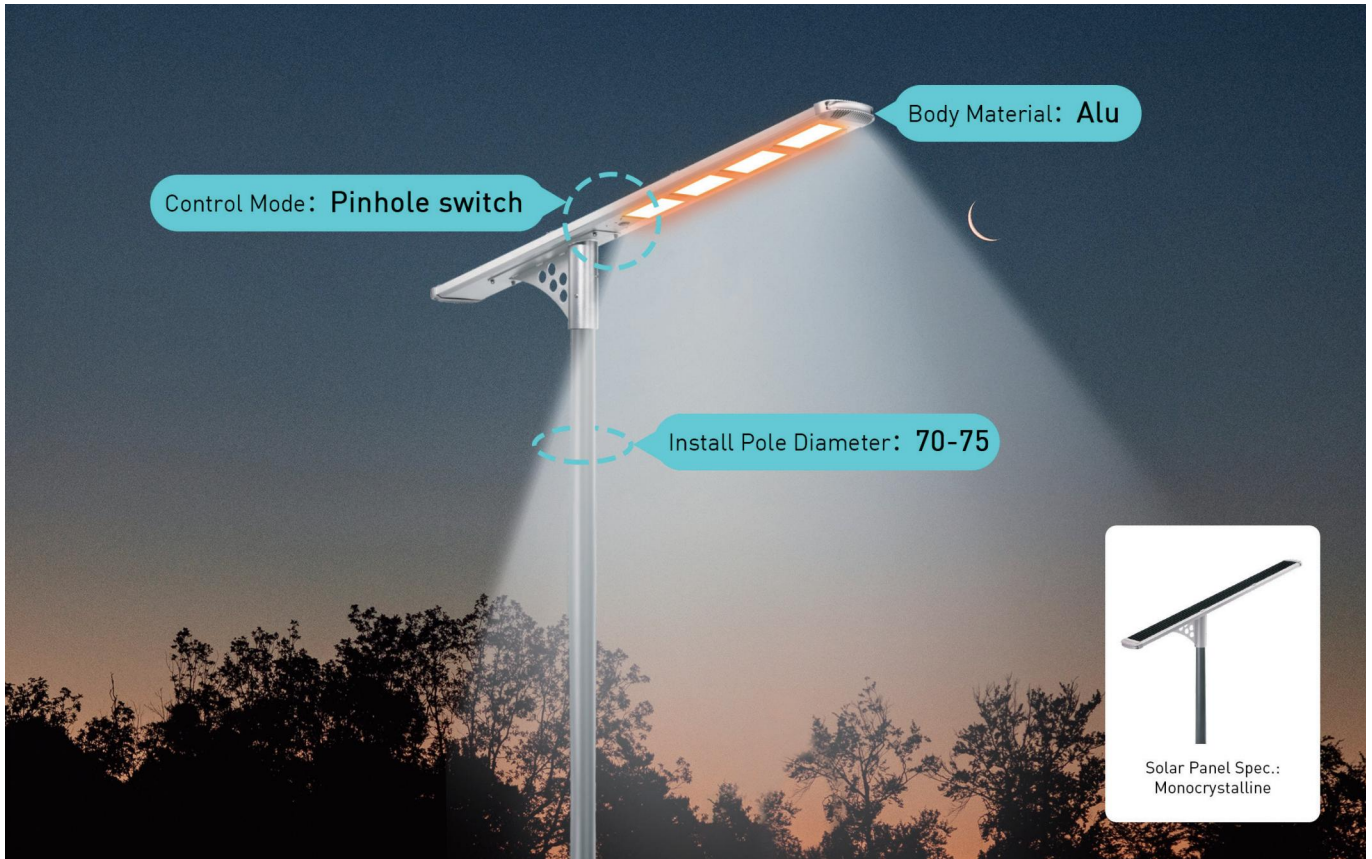

No Flicker



CRI:70/80



3000K-6500K



IP65



3-7 Cloudy/
Rainy Days



18650



6-10H



180°

18



E10



E20



E30



E50



E80

Model No. 产品规格	Rated Power 额定功率	Dimension W*H*T (mm)	Total Lumen 光通量	Solar Panel Size 太阳能板尺寸 (mm)	Battery Capacity 电池容量	PCS/CTN 装箱数量	CTN MEAS. 装箱尺寸 (mm)
XGYSSL-JKCG-E10	10W	530*235*150	1000LM	416*171*3.2	65.12WH12V	1	610*200*300
XGYSSL-JKCG-E20	20W	840*235*150	2000LM	728*171*3.2	76.8WH12.8V	1	920*200*300
XGYSSL-JKCG-E30	30W	1100*235*150	3000LM	990*171*3.2	153.6WH12.8V	1	1180*200*300
XGYSSL-JKCG-E50	50W	585*235*150 1630*235*150	5000LM	1510*171*3.2	230.4WH12.8V	1	LED Light Carton Size1680*140*300MM Accessories Carton Size :600*150*340MM
XGYSSL-JKCG-E80	80W	585*235*150 2000*235*150	8000LM	1810*171*3.2	307.2WH12.8V	1	LED Light Carton Size2050*140*300MM Accessories Carton Size :600*150*340MM

LED Solar Lighting



LED Solar Street Light

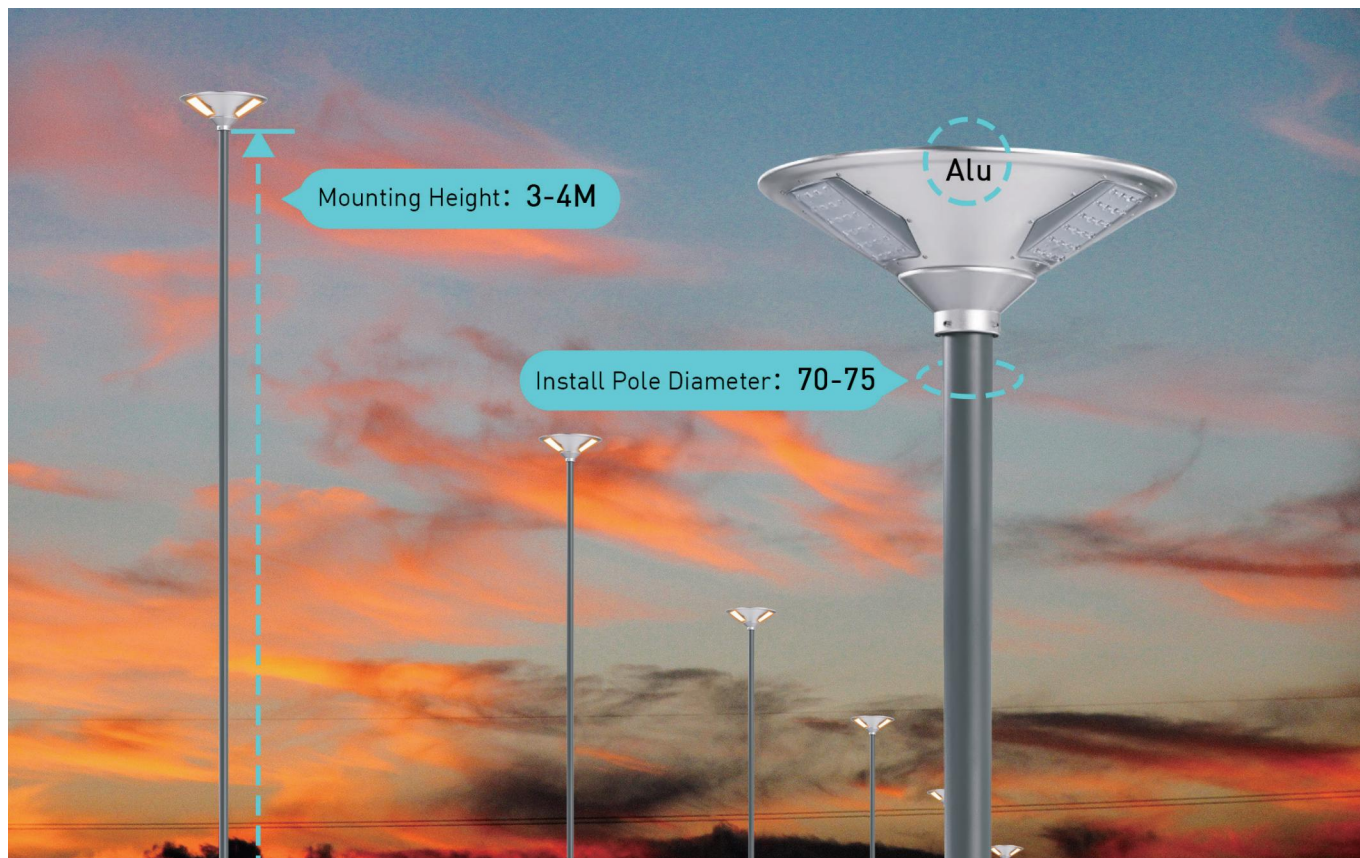

19



Control Mode: Remote



No Flicker



CRI:70/80



3000K-6500K



IP65



5-7 Cloudy/
Rainy Days



18650



9-10H



360°



E20



E30



E50

Model No. 产品规格	Rated Power 额定功率	Dimension W*H*T (mm)	Total Lumen 光通量	Solar Panel Spec. 太阳能板参数	Solar Panel Size 太阳能板尺寸 (mm)	Battery Capacity 电池容量	PCS/CTN 装箱数量	CTN MEAS. 装箱尺寸 (mm)
XGYSSL-JKCJ-E20	20W	570*570*230	2700LM	18V 30W Monocrystalline	562*562*3.2	153.6WH 12.8V	1	630*630*270
XGYSSL-JKCJ-E30	30W	660*660*240	4050LM	18V 40W Monocrystalline	642*642*3.2	230.4WH 12.8V	1	710*710*300
XGYSSL-JKCJ-E50	50W	760*760*250	6750LM	18V 50W Monocrystalline	724*724*3.2	307.2WH 12.8V	1	810*810*300